



Engineering Recommendation G12

Issue 4 Amendment 1(2015)

Requirements for the Application of Protective Multiple Earthing to Low Voltage Networks

PUBLISHING AND COPYRIGHT INFORMATION

© 2013 *Energy Networks Association*

All rights reserved. No part of this publication may be reproduced, stored in a retrieval system or transmitted in any form or by any means, electronic, mechanical, photocopying, recording or otherwise, without the prior written consent of Energy Networks Association. Specific enquiries concerning this document should be addressed to:

**Operations Directorate
Energy Networks Association
6th Floor, Dean Bradley House
52 Horseferry Rd
London
SW1P 2AF**

This document has been prepared for use by members of the Energy Networks Association to take account of the conditions which apply to them. Advice should be taken from an appropriately qualified engineer on the suitability of this document for any other purpose.

Amendments since publication

Issue	Date	Amendment
Issue 4	November 2013	The inclusion of a more comprehensive section on supplies to Rail installations which has been developed with input from Network Rail including the results of voltage rise tests; Improved guidance on other special situations to provide closer alignment with current Standards and Regulations and more accurately delineate areas of responsibility. Modifications directed by Ofgem have been included.
Amendment 1	December 2015	Section 6.2.14 – Clarification on the requirement to install Earth electrodes at street lighting mini pillars using PME supplies.

Contents

Foreword.....	6
1 Scope	7
2 Normative references.....	7
3 Terms and definitions.....	8
3.1 Aerial Bundled Conductor (ABC).....	8
3.2 Branch	8
3.3 Caravan	8
3.4 Distributing Main*.....	8
3.5 Distributor*	9
3.6 Electric Line*	9
3.7 Exhibition**	9
3.8 Marina**	9
3.9 Mobile/transportable Unit**	9
3.10 Basin of fountain**	9
3.11 Protective multiple earthing (PME)**	9
3.12 Protective neutral bonding (PNB).....	9
3.13 Residual current device (RCD)**	9
3.14 Service line*	10
3.15 Show**	10
3.16 Stand**	10
3.17 Street electrical fixture*	10
3.18 Supplier*	10
3.19 TN system**	10
3.20 TN-C system**	10
3.21 TN-S system**	10
3.22 TN-C-S system**	10
3.23 TT system**	10
4 Requirements for PME Networks	11
4.1 General.....	11
4.2 Substation earthing.....	11
4.3 Supply Neutral Conductor	11
4.3.1 Cross-sectional area	11
4.3.2 Maintaining integrity	11
4.4 Earthing of supply neutral conductor	11
4.4.1 Location of earth connections	11
4.4.2 Service line requirements.....	12
4.5 Underground cable networks	12
4.6 Overhead networks.....	15
4.7 Values of earth electrode resistance	15
4.8 Type of earth electrodes	15
4.9 Type and size of earthing and bonding connections.....	15

4.10	Insulation of neutral earthing conductors.....	16
4.11	Protective neutral bonding (PNB).....	16
5	Consumers Installations.....	17
5.1	Consumers on existing networks	17
5.2	Earthing terminal.....	18
5.2.1	Provision of earth terminal.....	18
5.2.2	Connection to supply neutral conductor	18
5.2.3	Connection to cable sheath/armouring at service termination	18
5.3	Polarity testing	18
5.4	Labels and notices.....	18
6	Special Situations	19
6.1	General.....	19
6.2	Consideration of special situations.....	19
6.2.1	Auxiliary LV supplies associated with railways and tramways	19
6.2.1.1	General	19
6.2.1.2	LV supplies associated with AC electrified systems.....	19
6.2.1.3	LV supplies associated with DC electrified systems.....	20
6.2.1.4	LV supplies for sites with both AC and DC traction systems	21
6.2.1.5	Other electrified systems	21
6.2.2	Construction and demolition sites.....	21
6.2.2.1	TN-S from a dedicated transformer	21
6.2.2.2	TT Earthing system with RCD protection	21
6.2.2.3	Transition to permanent supply.....	22
6.2.3	Supplies to temporary installations (not associated with construction sites)	22
6.2.3.1	Exhibitions, shows and stands.....	22
6.2.3.2	Mobile or transportable units	22
6.2.3.3	Temporary electrical installations for structures, amusement devices and booths at fairgrounds, amusement parks and circuses	23
6.2.3.4	Supplies to other temporary buildings.....	23
6.2.4	Agricultural and horticultural premises.....	23
6.2.5	Swimming Pools and other basins	24
6.2.6	Caravans, boats, marinas, camp sites and amenity/shower blocks (including sports pavilions).....	25
6.2.6.1	Caravans.....	25
6.2.6.2	Caravan sites, campsites and amenity shower blocks	25
6.2.6.3	Boats and marinas.....	25
6.2.7	Mobile homes.....	25
6.2.8	Mines and quarries.....	26
6.2.9	Fuel filling stations.....	26
6.2.10	Multiple occupancy buildings.....	26
6.2.11	External exposed metalwork connected to the internal earth system (including outside water taps).....	26
6.2.12	Metal clad buildings.....	26

6.2.13	LV Embedded generators	27
6.2.14	Street lighting and road signs with electrical load of 500W or less.....	27
6.2.15	Street Electrical Fixtures not covered by 6.2.14	30
6.2.16	Lightning protection systems	30
6.2.17	Cathodic Protection Installations	31
6.2.18	Communication stations	31
6.2.18.1	Communication stations with an independent earth electrode	31
6.2.18.2	Communication station housings/structures accessible to the public.....	31
6.2.18.3	Shared communication tower/mast.....	31
6.2.18.4	TN-S alternative.....	32
6.2.18.5	Communication stations on/in other buildings.....	32
Appendix 1:	Extract from the Electricity Safety, Quality and Continuity Regulations 2002, as amended.....	34
Appendix 2:	Operators of AC Electrified Traction Systems in the UK.....	36
Appendix 3:	DC electrified traction systems in the UK	37

Foreword

This Engineering Recommendation (EREC) is published by the Energy Networks Association (ENA) and comes into effect from 1st February 2014. It has been prepared under the authority of the ENA Engineering Policy and Standards Manager and has been approved for publication by the ENA Electricity Networks and Futures Group (ENFG). The approved abbreviated title of this Engineering document is “EREC G12 issue 4”, which replaces the previously used abbreviation “ER G12/3”.

This Engineering Recommendation takes account of:

- i) The Electricity Safety, Quality and Continuity Regulations 2002, as amended

NOTE: Regulation 9 gives requirements for PME; the DTI Guidance Document “Guidance on the Electricity Safety, Quality and Continuity Regulations 2002”, Section 9, refers to Engineering Recommendation G12.

- ii) BS 7671 : Requirements for Electrical Installations

1 Scope

This Engineering Recommendation sets out the requirements to be adopted when Protective Multiple Earthing (PME) is applied to DNO (Distribution Network Operator, including Independent Distribution Network Operator) overhead and underground low voltage distribution systems and to other public distribution systems connected to those systems under the Distribution Code. These requirements may be supplemented by each Company's own PME code of practice in respect of the detailed engineering and technical requirements of PME application. The requirements in this Engineering Recommendation aid compliance with certain aspects of the requirements of the Electricity Safety, Quality and Continuity Regulations 2002, as amended. The document also considers situations where PME should not normally be used.

2 Normative references

The following referenced documents, in whole or part, are indispensable for the application of this document. For dated references, only the edition cited applies. For undated references, the latest edition of the referenced document (including any amendments) applies.

This document makes reference to, or should be read in conjunction with, the following documents:

Statutory publications

The Electricity Safety Quality and Continuity Regulations 2002 (SI 2002 No. 2665), as amended

The Electricity at Work Regulations 1989 (SI 1989 No. 635), as amended

Standards publications

BS 7375: Code of practice for distribution of electricity on construction and building sites

BS 7430: Code of practice for earthing

BS 7671:2008 (2011) Requirements for electrical installations. IET Wiring Regulations. Seventeenth Edition

BS 7870-5: LV and MV polymeric insulated cables for use by distribution and generation utilities. Part 5: Polymeric insulated aerial bundled conductors (ABC) of rated voltage 0.6/1kV for overhead distribution

BS 7909: Code of practice for temporary electrical systems for entertainment and related purposes

BS EN 50122-1: Railway applications. Fixed installations. Protective provisions relating to electrical safety and earthing

BS EN 50122-2: Railway applications. Fixed installations. Protective provisions against the effects of stray currents caused by d.c. traction systems

BS EN 62305: Protection against lightning

IEC/TS 60479-1: Effects of current on human beings and livestock. General aspects

ENA Publications

TS 41-24: Guidelines for the design, installation, testing and maintenance of main earthing systems in substations

TS 43-13: Aerial bundled conductors insulated with cross-linked polyethylene for low voltage overhead distribution

EREC C93: Type approval tests for mechanical connections to metallic sheaths of cables

EREC G14: PME. Recommended principles of testing to ensure correct polarity

EREC G59: Recommendations for the connection of generating plant to the distribution systems of licensed Distribution Network Operators

EREC G83: Recommendations for the connection of type tested small-scale embedded generators (up to 16A per phase) in parallel with low voltage distribution systems

EREC G87: Guidelines for the provision of low voltage connections to multiple occupancy buildings

EREC P24: AC traction supplies to British Rail

EREC S34: A guide for assessing the rise of earth potential at substation sites

EREP 123: Guidelines for managing the interfaces between utility services and light rapid transit systems

3 Terms and definitions

For the purposes of this document, the following terms and definitions apply.

NOTE: Definitions marked with an asterisk are taken from the Electricity Safety, Quality and Continuity Regulations 2002, as amended. Those with a double asterisk are taken from BS 7671:2008 (2011).

3.1 Aerial Bundled Conductor (ABC)

A fully insulated, 4-wire low voltage overhead distribution system, where the wires are bundled, erected and secured as though it were a single overhead line conductor, complying with the requirements of BS 7870-5 and TS 43-13.

3.2 Branch

A sub-division of a distributing main from its end furthest from the source of voltage to its junction with the distributing main.

A branch may be classified as a service line provided that:

- it connects no more than four consumers' installations, of which one or more has a PME earthing terminal

and:

- it is no more than 40 metres in length from its point of connection to the distributing main.

3.3 Caravan

A trailer leisure accommodation vehicle, or:

A motor caravan or motor home, or:

A mobile home or residential park home if certain conditions apply; namely, if any metalwork connected to the earth terminal is within reach of a person in contact with the general mass of earth or they are not permanently sited or not permanently connected to water/sewerage services.

NOTE: "Caravan" is a legally defined term which includes tents.

3.4 Distributing Main*

A low voltage electric line which connects a distributor's source of voltage to one or more service lines or directly to a single consumer's installation.

NOTE: A distributing main supplying a single consumer may, in other contexts (e.g. charging, planning consent for OH service) be described as a service.

3.5 Distributor*

A person who owns or operates a network, except for a network situated entirely offshore or where that person is an operator of a network within the meaning of Part I of the Railways Act 1993 or an operator of a tramway, a trolley vehicle system or guided transport.

3.6 Electric Line*

Any line which is used or intended to be used for carrying electricity for any purpose and includes, unless the context otherwise requires:

- a) any equipment connected to any such line for the purpose of carrying electricity;
- b) any wire, cable, tube, pipe, insulator or other similar thing (including its casing or coating) which surrounds or supports, or is associated with, any such line".

3.7 Exhibition**

Event intended for the purpose of displaying and/or selling products etc., which can take place in any suitable location, either a room, building or temporary structure.

3.8 Marina**

Facility for mooring and servicing of pleasure craft with fixed wharves, jetties, piers or pontoon arrangements capable of berthing one or more pleasure craft.

3.9 Mobile/transportable Unit**

A vehicle and/or mobile or transportable structure in which all or part of an electrical installation is contained, which is provided with a temporary supply by means of, for example, a plug and socket-outlet.

3.10 Basin of fountain**

A basin not intended to be occupied by persons and which cannot be accessed (reached by persons) without the use of ladders or similar means. For basins which may be occupied by persons, the requirements for swimming pools apply.

3.11 Protective multiple earthing (PME)**

An earthing arrangement, found in TN-C-S systems, in which the supply neutral conductor is used to connect the Earthing conductor of an installation with earth, in accordance with the Electricity Safety, Quality and Continuity Regulations 2002, as amended.

3.12 Protective neutral bonding (PNB)

PNB refers to the situation where there is only one point in a network at which consumers' installations are connected to a single source of voltage. In such a case, the supply neutral conductor connection to earth may be made at that point or at another point nearer to the source of voltage.

3.13 Residual current device (RCD)**

Mechanical switching device or association of devices intended to cause the opening of the contacts when the residual current attains a given value under specified conditions.

3.14 Service line*

An electric line which either connects a street electrical fixture, or no more than four consumers' installations in adjacent buildings, to a distributing main.

3.15 Show**

Display or presentation in any suitable location, either a room, building or temporary structure.

3.16 Stand**

Area or temporary structure used for display, marketing or sales.

3.17 Street electrical fixture*

A permanent fixture which is or is intended to be connected to a supply of electricity and which is in, on, or is associated with a highway.

3.18 Supplier*

A person who contracts to supply electricity to consumers.

3.19 TN system**

A system having one or more points of the source of energy directly earthed, the exposed conductive-parts of the installation being connected to that point by protective conductors.

3.20 TN-C system**

A system in which neutral and protective functions are combined in a single conductor throughout the system.

NOTE: Systems using combined neutral/earthed concentric wiring or combined neutral/earthed sheath return wiring are both examples of a TN-C system.

3.21 TN-S system**

A system having separate neutral and protective conductors throughout the system.

NOTE: A system where the metallic path between the installation and the source of energy is the sheath and armouring of the supply cable is a TN-S system.

3.22 TN-C-S system**

A system in which neutral and protective functions are combined in a single conductor in part of the system.

NOTE: A system with PME applied to it is an example of a TN-C-S system: in the distribution system the neutral and protective conductors are combined; in the consumer's installation the neutral and protective conductors are separate.

3.23 TT system**

A system having one point of the source of energy directly earthed, the exposed-conductive-parts of the installation being connected to earth electrodes electrically independent of the earth electrodes of the source.

4 Requirements for PME Networks

4.1 General

The following paragraphs set out the requirements for new and existing LV networks to enable the adoption of PME.

4.2 Substation earthing

In HV/LV substations feeding PME networks, the rise of earth potential on the neutral/earth shall not exceed 430V during a fault in the HV system. If calculations show that under high voltage earth fault conditions the transfer potential from the HV system can exceed this value, the earthing systems shall be segregated. The physical segregation shall be such that the above requirement is achieved.

NOTE: TS 41-24 and EREC S34 give further details on substation earthing and rise of earth potential.

4.3 Supply Neutral Conductor

No protective device shall be included in the supply neutral conductor or any earthing connection of a low voltage network. All reasonable precautions shall be taken to ensure continuity of the supply neutral conductor.

4.3.1 Cross-sectional area

The supply neutral conductor in any three phase four wire, or single phase three wire (split phase) distributing main or service shall not be less than half the equivalent cross-sectional area of the phase conductors.

In the case of single phase two wire or two phase three wire distributing mains and services the cross-sectional area of the supply neutral conductor shall be not less than the equivalent cross-sectional area of the phase conductor, with recommended minimum values of:

- 10 mm² for copper conductors
- 16 mm² for aluminium conductors.

NOTE: The terms "single phase three wire" and "split phase" are commonly used to describe a two-phase, three wire, phase angle 180° system according to BS 7671 Section 312. The term "two phase three wire" is commonly used to describe a two phase, three wire, phase angle 120° system according to BS 7671 Section 312.

4.3.2 Maintaining integrity

In view of the importance of avoiding the possibility of an open circuit in the supply neutral conductor, it is essential to pay particular attention to its integrity through the design, construction, maintenance and operation of the distribution system.

The design of conductors, cables, joints and terminations shall be such as to minimise the risk of an open circuit of the neutral.

4.4 Earthing of supply neutral conductor

4.4.1 Location of earth connections

In addition to the LV neutral earth at or near the substation, the supply neutral conductor shall be connected at other points either to earth electrodes or to the supply neutral conductor of another distributing main. A connection shall be made on each distributing main or branch to which a service line with a PME earthing terminal is to be connected and this connection shall not be nearer to the substation than the most remote service line having a PME earthing terminal. A connection may be made at a service termination and if necessary

an earth electrode installed, but neither the consumer's earthed metalwork nor gas and water service pipes shall be used for this purpose.

Where there is a network boundary between licensed network operators, a neutral/earth electrode shall be installed at the boundary point.

4.4.2 Service line requirements

If a branch has been classified as a service line, there is no requirement to provide an earth. This relaxation does not apply to service lines to street electrical fixtures, see paragraph 6.2.14.

NOTE: Figure 4.4 gives examples of the application of paragraphs 4.4.1 and 4.4.2.

4.5 Underground cable networks

Where PME facilities are available to consumers, the following requirements apply when combined neutral and earth (CNE) cables are incorporated into networks containing cables with separate neutral and earthing conductors (SNE cables). Additional requirements are given in paragraph 5.1 for networks where SNE earth terminals have previously been provided to existing consumers.

Wherever possible, CNE cables shall be used for reinforcement, diversions, and repairs to existing systems. The neutral to sheath bonding and neutral earthing requirements of such systems shall be in accordance with paragraphs 4.4.1, 4.4.2, Figure 4.4 and any additional requirements shown in Figure 4.5. Details of the appropriate size of conductor for neutral to sheath bonds and neutral earth connections may be found in paragraph 4.9.

An earth electrode shall be provided at the end of the section of CNE cable most remote from the distribution substation. The neutral of each section of CNE cable shall be bonded to the neutral/sheath of the adjacent SNE cable. The whole of the distributing main between the substation and this earth electrode will then be suitable for PME.

PME can be applied to the remote sections of SNE distributing mains by bonding the earth and neutral conductors at the end of the SNE distributing main and where necessary installing an earth electrode.

A suitable length of metallic sheath of an SNE cable laid direct is considered to be an earth electrode (see paragraph 4.8).

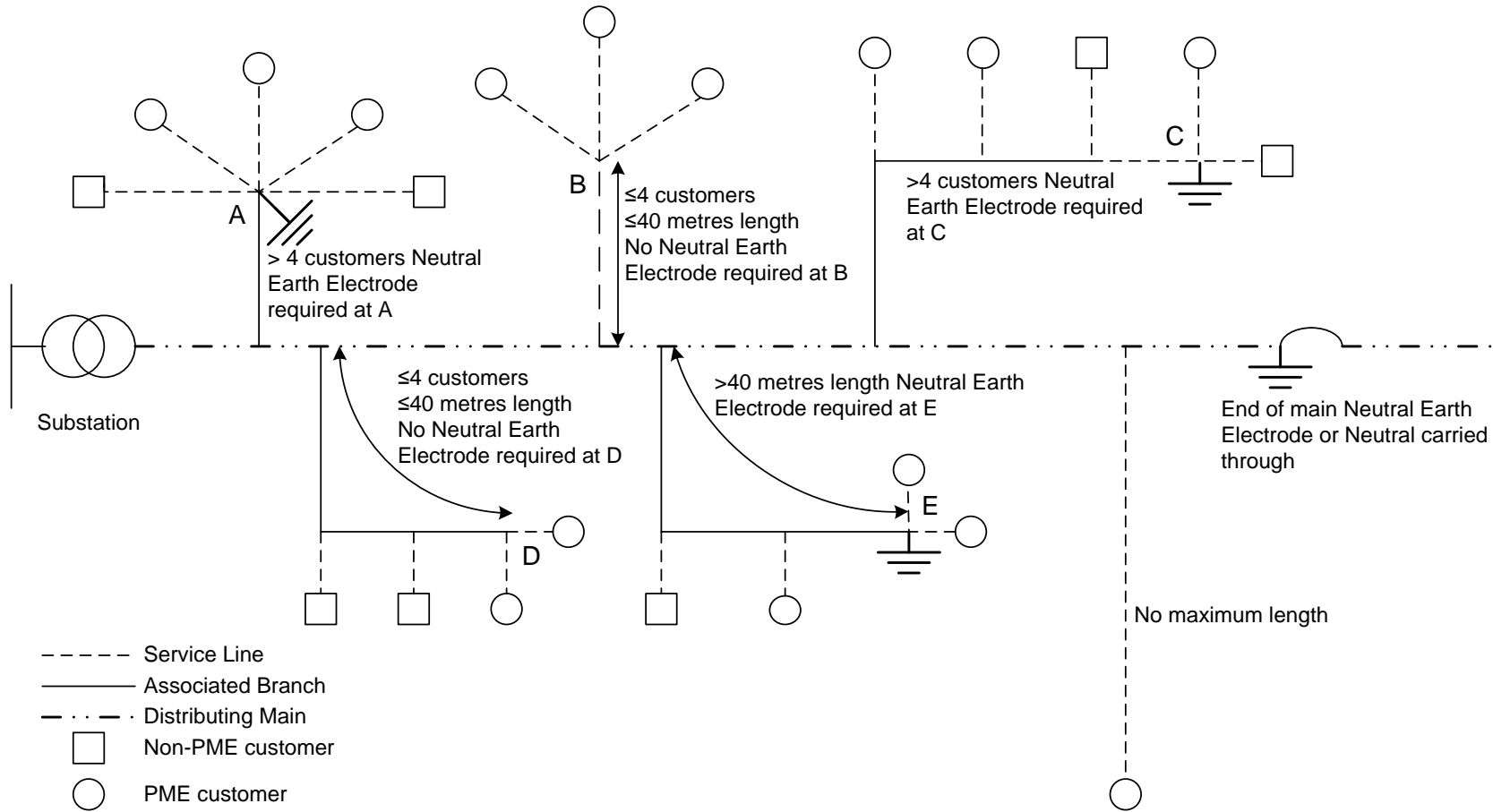

Figure 4.4 Installation of electrodes along branches of distributors

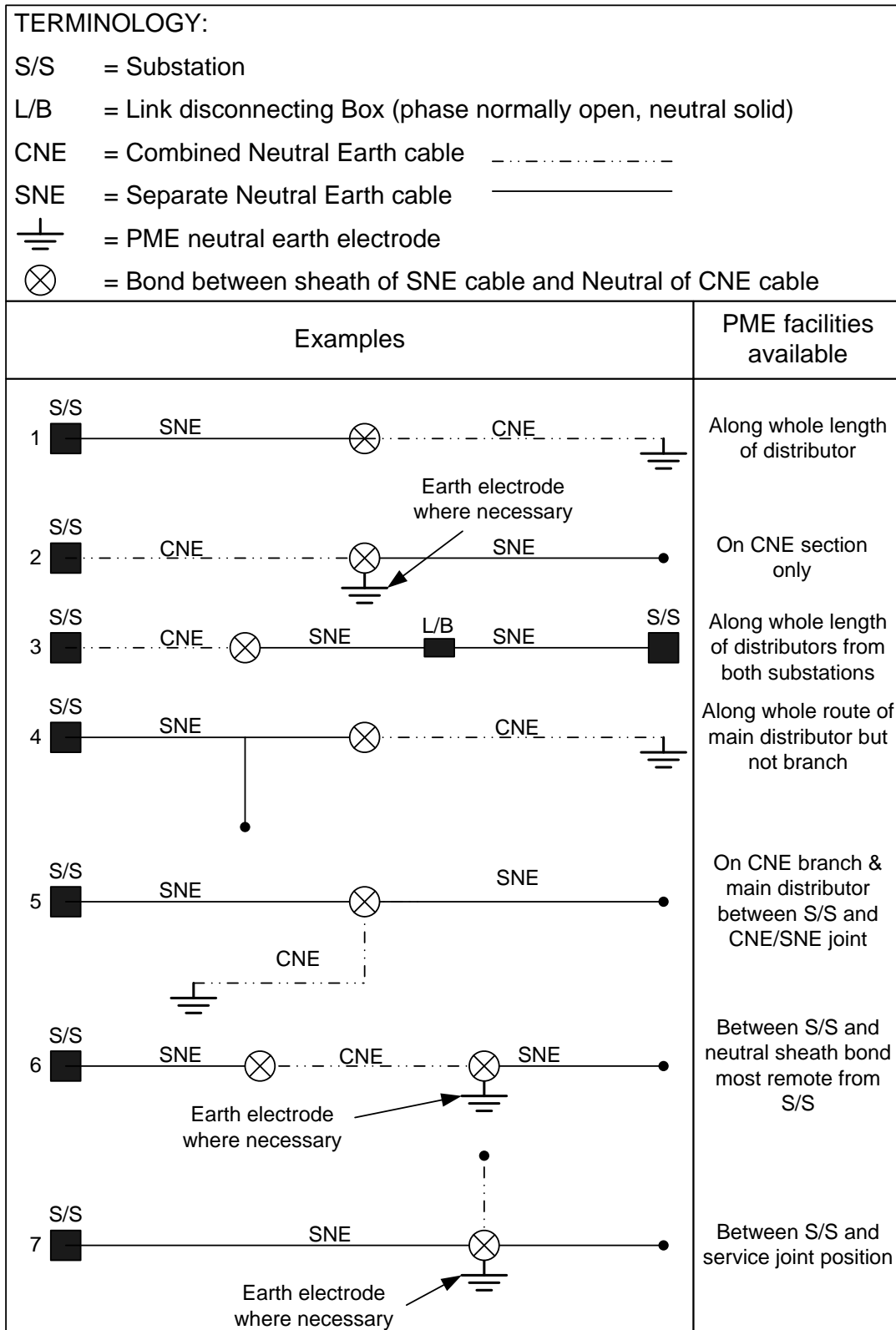

Figure 4.5 Typical application of PME to networks with SNE and CNE cables

When a new CNE service, or an existing service replaced by a CNE cable, is connected to an SNE distributing main which does not already form part of a PME system, the consumer

may be provided with a PME earth terminal provided that an earth electrode is connected to the neutral at the service joint.

4.6 Overhead networks

The principles applied in PME underground systems also apply to overhead systems or mixed overhead and underground PME systems.

When converting systems with a separate earth conductor to PME, all overhead sections of associated main and any other main likely to be used as an alternative supply, between the supply substation and the connection to the consumer being offered PME, shall meet the requirements of this Engineering Recommendation.

Additional neutral earth electrodes may be required at intervals along the line in order to maintain the neutral to earth resistance below the required value (see 4.7).

NOTE 1: It is found that neutral earth electrodes installed at intervals not greater than 8 spans will generally achieve this value.

NOTE 2: Overhead systems are more exposed to the elements so are more likely to lose an earth connection.

On poles supporting cable terminations, the sheaths and metallic termination boxes shall be bonded to the neutral conductor.

Undereaves wiring should be considered as part of the distribution network and the definitions of service line and distribution main applied.

4.7 Values of earth electrode resistance

Substation LV neutral earth electrode resistance shall be sufficiently low for HV protection to clear an interwinding fault and shall not exceed the value specified in TS 41-24.

The combined resistance of all LV neutral earth electrodes shall not exceed 20 ohms (before the connection of consumers' earthing terminals to the neutral).

4.8 Type of earth electrodes

Earth electrodes provided to meet the requirements of this Engineering Recommendation shall whenever possible consist of driven rods to TS 43-94. Where this is not appropriate e.g. sites where rock is close to the surface of the ground, plates or copper conductor may be buried.

Where several driven rods are used to form an electrode system, and space is available, the mutual separation should not be less than twice the depth to which the rods are driven.

NOTE: Metallic joint boxes, link disconnecting boxes or non-insulated metallic cable sheaths of SNE cables which are electrically continuous and in direct contact with the general mass of earth for a minimum length of 5 to 20 metres may be suitable earth electrodes dependent upon local soil conditions.

4.9 Type and size of earthing and bonding connections

Earthing and bonding connections where buried direct in the ground shall preferably be of copper conductor. Where aluminium connections are used both the conductor and the joint to the earth electrode shall be adequately protected against corrosion.

The minimum size of earthing and bonding connections for copper conductors shall be as shown in Table 4.9a. For non-copper conductors or copper alloys, the cross sectional area shall be such as to give a conductance (or continuous rating) equivalent to that of copper. Currents in PME earthing conductors may flow for an extended duration. In calculating the 'copper equivalent' cross sectional area of a conductor it is therefore not appropriate to use short-time equivalent ratings such as are typically quoted for protective conductors.

Type of conductor	Minimum copper equivalent CSA
Earth leads to neutral earth electrode	16mm ²
Bonding connection between neutral busbar and earth busbar at substation	To be not less than half the current carrying capacity (where appropriate) of the largest phase conductor in the distributing main.
Bonding connections to link boxes and network feeder pillars (where applicable)	32mm ²
At consumers' premises, connection between service neutral and earthing terminal	16mm ² or half the size of the neutral meter tail, whichever is the larger
At consumers' premises connection between the earthing terminal and the earth bar of the consumer unit.	See BS 7671.
Connection between sheath of SNE cable and neutral of CNE cable	32mm ²
At consumers' premises the main equipotential bonding connections between the earthing terminal and all metal structures, metal pipes and other extraneous-conductive-parts.	See BS 7671.

Table 4.9a: Type & size of earth connection for copper conductors

To assist with the sizing of earthing and main protective bonding conductors, the copper equivalent cross-sectional areas of the supply line and neutral conductors for a range of typical DNO incoming cables are listed in Table 4.9b.

Typical DNO incoming cable	Copper equivalent cross-sectional area of supply line conductor	Copper equivalent cross-sectional area of supply neutral conductor
35mm ² Al CNE	22mm ²	22mm ²
95mm ² Al CNE	60mm ²	60mm ²
185mm ² Al CNE	116mm ²	116mm ²
300mm ² Al CNE	190mm ²	116mm ²
300mm ² Cu CNE	300mm ²	150mm ²

Table 4.9b: Typical DNO incoming cable conductor sizes

4.10 Insulation of neutral earthing conductors

Where the HV metalwork and LV system earths are separated, LV neutral earthing conductors shall be insulated with PVC of minimum thickness 0.8mm or equivalent.

4.11 Protective neutral bonding (PNB)

PNB may be adopted if the number of consumers is 4 or less and their distance from the connection to earth is 40m or less.

The LV neutral conductor shall be connected to an earth electrode at a point remote from the transformer, between the transformer and the supply terminals of the consumer(s). The distance between the connection to earth and the consumers' intake shall be 40m or less; however in order to minimise the risk of voltage rise in the event of a broken neutral this connection should be made as close as is practicable to the consumers' supply terminals. The metallic sheaths of any LV cables shall also be connected to the earth electrode. The resistance of the earth electrode shall not exceed 40 ohms.

The transformer tank and associated HV metalwork will be connected to a HV earth electrode. All uninsulated parts of this electrode shall be separated from any part of the LV earth electrode and any earthed metalwork connected to it.

PNB can apply to both three phase and single phase connections.

Earth terminals provided using PNB shall be treated in all respects as PME earth terminals.

5 Consumers Installations

5.1 Consumers on existing networks

Where consumers' installations use SNE earth terminals all reasonable precautions shall be taken to ensure that the safety of these consumers is not adversely affected by modifications or additions to existing networks.

Where CNE cable is introduced into SNE networks, existing SNE consumers' installations may retain an SNE earth provided that:

- a continuous metallic earth return path exists to the source substation,
- and
- they are connected to a length of electrically continuous non-insulated metallic sheath cable, sufficient to control the rise of potential to acceptable levels under open-circuit neutral conditions, having considered the requirements of IEC/TS 60479-1. By experience this criterion will be met provided the resistance to earth of the metallic sheath is 10 ohms or less or an individual earth electrode is provided with a resistance of less than 10 ohms. Where in specific circumstances the 10 ohm value cannot be achieved, a value up to 20 ohms is acceptable where it can be shown by calculation that any voltage rise on the neutral conductor of the 3-phase cable is limited to 100V.

If these conditions cannot be met there should be discussions with existing SNE consumers who may wish to convert to PME provided their bonding complies with paragraph 5.2.1. Alternative earth fault protection may be provided if the consumer operates an installation forming part of a TT system by installing a separate earth electrode and fitting appropriate protection in accordance with BS 7671 (eg an RCD). Alternatively, SNE earths may be maintained by running a separate earth cable along with the section of CNE cable. Where this option is chosen the neutral and earth should remain separate and be so constructed as to minimise the risk of deterioration or damage.

On overhead networks containing continuous earth wires (CEW) when the 5 wire sections are replaced by CNE cable, or 4 wire ABC, it is preferable from a technical point of view for all existing SNE consumers to be converted to PME provided their earthing and bonding complies with paragraph 5.2.1. If not, a suitable earth electrode and appropriate protection in accordance with BS 7671 (eg an RCD) should be installed to provide earth fault protection. Existing consumers beyond the CNE or ABC insert may retain their SNE earth provided the earth is connected to a sufficient length of SNE cable such that the resistance to earth of the metallic sheath is 10 ohms or less. Where in specific circumstances the 10 ohm value cannot be achieved, a value of up to 20 ohms is acceptable where it can be shown by calculation that any voltage rise on the neutral conductor of the 3-phase circuit is limited to 100V.

At the junction of the 5 wire system and the CNE or ABC section, the neutral of the CNE or ABC must be bonded to the neutral and earth of the 5 wire system and an earth electrode installed.

Where none of these solutions can be applied, a 4-core metallic sheathed cable or separate earth conductor should be installed. The sheath or earth conductors shall be connected to

the SNE cable sheath or CEW earth conductor at each end with the neutral and earth remaining separate.

5.2 Earthing terminal

5.2.1 Provision of earth terminal

PME earth terminals can be offered to consumers unless there are reasonable grounds to believe either:

- their earthing installation is not designed to BS 7671.
- or
- the type of installation is not suitable for PME. (See Section 6 for examples where it may not be possible to provide a PME earth terminal).

Where a metallic gas service is provided to a consumer's premises with a PME earth terminal, an insulated insert should be fitted in the gas service.

5.2.2 Connection to supply neutral conductor

Where a consumer's earth terminal is provided, it shall be connected to the supply neutral conductor at the service position by either a copper conductor with a minimum cross-sectional area as specified in paragraph 4.9 or a cut-out incorporating an integral earthing terminal. Any bolted link between the neutral and the earthing terminal shall be of equivalent cross-sectional area.

5.2.3 Connection to cable sheath/armouring at service termination

The metallic sheath and armouring of underground service cables shall be connected to the earthing terminal, neutral terminal or neutral connector block as appropriate, by means of a copper conductor of minimum cross-sectional area as specified in paragraph 4.9. The connection to the cable sheath should be made by means of either an earthing clamp (e.g. one which complies with EREC C93), or a substantial sweated connection.

Where service cables with a concentric neutral are used, the concentric neutral and any separate earth conductor shall be connected to the earthing terminal, neutral terminal or neutral connector block, as appropriate.

5.3 Polarity testing

Polarity testing shall be performed prior to connection at the cut-out and supply terminals. Further information on the general principles of polarity testing is given in EREC G14.

NOTE: If the phase and neutral conductors are crossed on a PME service, a dangerous situation could arise in that the consumer's metalwork becomes live at line voltage. In these circumstances the earth in the vicinity of the premises also tends to rise to line voltage and tests intending to establish polarity may be misleading if not carried out correctly.

5.4 Labels and notices

Where PME facilities are available to a consumer, a label shall be affixed at the service position drawing attention to the fact that the service is connected to a network having protective multiple earthing.

6 Special Situations

6.1 General

A PME earthing terminal provides a satisfactory means of protection for the majority of installations. There are, however, a number of special situations where PME is not a suitable method of earthing: in such situations, if a PME earth terminal is utilised, the rise of voltage on a consumer's earth terminal in the event of a broken neutral may pose an unacceptable risk. In these cases the consumer must utilise an additional or alternative form of fault protection such as a TT system earthing arrangement by installing a separate earth electrode and fitting appropriate protection in accordance with BS 7671 (eg an RCD).

Where the use of PME is precluded in any consumer's installation or part thereof the earthed metalwork of the TT system associated with the use of an RCD or other protection must be segregated from any metalwork associated with the PME system.

It is **not** acceptable in these situations to provide an SNE service from a PME main since any rise of voltage on the neutral of the main will be transferred to the consumer's earth terminal.

NOTE: Specific requirements for various specialised installations can be found in BS 7671.

6.2 Consideration of special situations

This section sets out requirements for certain types of 'special situations'. Although the list of situations covered is not intended to be exhaustive, it may be possible to apply the principles underlying the special situations to determine requirements in other circumstances.

6.2.1 Auxiliary LV supplies associated with railways and tramways

This clause sets out the requirements for providing PME earth terminals to operators of railway systems.

6.2.1.1 General

For any supply with a PME earth terminal:

- a) All installations shall comply with the requirements of BS 7671, including equipotential bonding under PME conditions;
- b) The housing at the intake position shall not expose a member of the general public to dangerous touch potentials.
- c) Metal housings containing LV equipment are not permitted at the intake position or where they may expose a member of the general public to dangerous touch potentials.

The above measures do not necessarily provide full protection against touch potentials for railway personnel. It is the responsibility of the railway operator to assess and control such risks.

6.2.1.2 LV supplies associated with AC electrified systems

Specific information about the compliance of individual railway operators is set out in Appendix 2.

a) LV auxiliary supplies at traction supply points

The requirements for auxiliary LV supplies at traction supply points for ac systems are set out in EREC P24. Because of the traction return currents that will be flowing through earth at these sites PME earth terminals are not permitted at these locations.

b) LV auxiliary supplies at locations other than traction supply points

The requirements for earthing of electrical installations on railway lines with AC electrification are governed by railway sector design standards that can result in higher touch voltages than are permitted on the PME network.

NOTE: These standards include BS EN 50122-1 and the Railway Group Standard GL/RT1255.

Therefore, more stringent limits than those set by these standards are required to ensure that dangerous voltages are not exported to DNO LV networks through a PME earth conductor.

PME supplies may be made available subject to the railway operator confirming that their design standards will ensure that:

1. In the case of traction supply faults the earthing standards will limit the rise of earth potential to the following values as specified by TS 41-24 :
 - 430V for faults with a duration greater than 0.2s, but not greater than 3s;
 - 650V for faults with a duration not greater than 0.2s.
2. The rise of voltage on the traction rail due to traction return current shall not exceed 25V under frequent traction peak starting or running current conditions.

6.2.1.3 LV supplies associated with DC electrified systems

PME Earth Terminals may be provided to premises and trackside cubicles associated with lines electrified using 3rd or 4th rail systems subject to the following conditions:

- a) The traction current supply (3rd rail or overhead) and return (running rails and/or 4th rail) rails are insulated from earth in accordance with the requirements of BS EN 50122-2.
- b) Neither pole of the traction supply is directly connected to earth.
- c) Any connection to earth is solely for the purpose of the detection of earth fault conditions.
- d) The LV supply, including the protective earthing conductor, and all earthed metal associated with it is segregated from all DC conductors by the maximum practicable distance, subject to a minimum distance of 1m in accordance with BS EN 50122-2.
- e) In the event that the railway operator detects corrosion due to stray DC current on any of their equipment they shall advise the DNO providing associated PME earthing facilities .

These requirements are set in place in order to minimise the risk of electrolytic corrosion of earthing systems due to stray DC currents. They are based on a recognition that, if stray currents exist, there will be paths electrically closer to the traction system which will take larger stray currents than will flow through a DNO LV earthing system. In this case corrosion of cable sheaths, structures and earthing systems, which are subject to regular inspections, will quickly become apparent to the railway operator.

These measures will also ensure that for PME systems no external voltage is impressed on the neutral/earth conductor.

Information on methods of construction of DC electrified systems in the UK is given in Appendix 3.

NOTE: The requirements concerning DC electrified systems are also applicable to supplies using SNE service cables.

6.2.1.4 LV supplies for sites with both AC and DC traction systems

Where sites have both AC and DC electrified systems, a PME earthing terminal shall not be provided.

6.2.1.5 Other electrified systems

Requirements for the provision of earthing terminals to premises and equipment at the trackside of operators of other traction system are subject to agreement between the traction system operator and the relevant DNO.

In the case of Light rapid transit systems reference should be made to EREP 123.

6.2.2 Construction and demolition sites

The following sections specify the types of earthing systems that can be used for temporary construction and demolition site supplies. As it is usually impractical to comply with the bonding requirements of BS 7671, a PME supply should not be offered, except for the supply to a fixed building of the construction site. The following sections specify the types of earthing system that can be used.

In addition to the arrangements shown in 6.2.2.1 and 6.2.2.2, if the site does not have a dedicated transformer, ie the transformer supplies other consumers or other parts of the LV network, it is still possible to provide a TN-S earthing system within the boundary of the site via a suitable isolating transformer.

The transition from a temporary to a permanent supply must be taken into account, and both supplies should be considered during the design and planning stages. Refer also to BS 7375.

6.2.2.1 TN-S from a dedicated transformer

If the site has a dedicated secondary substation that only supplies the consumer it will usually be possible to provide a TN-S earth terminal directly from the transformer neutral - see figure 6.2.2.1. This arrangement will also enable a permanent supply to be provided more easily when required.

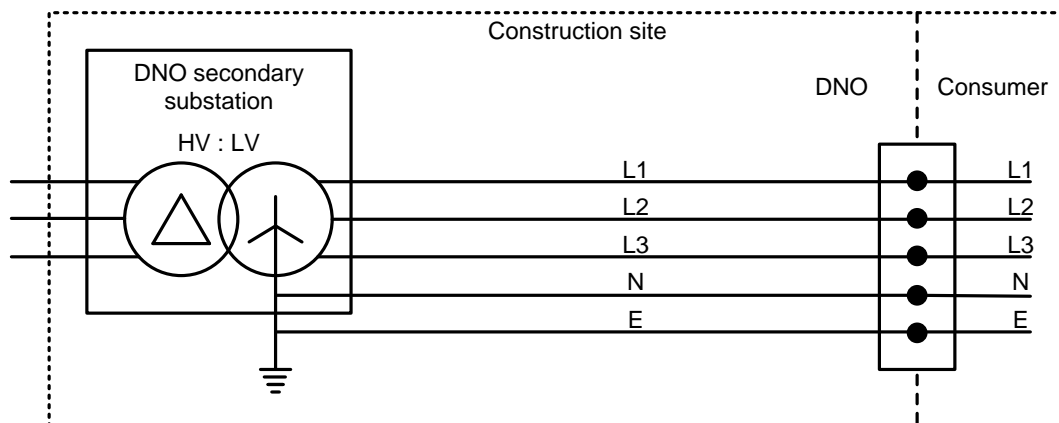

Figure 6.2.2.1: TN-S earth from a dedicated transformer

The developer/contractor will be responsible for maintaining the LV supply.

6.2.2.2 TT Earthing system with RCD protection

In the absence of any other earthing system a TT earthing system shall be used, as shown in figure 6.2.2.2.

The supply must be protected in accordance with BS 7671; this will usually include a residual current device (RCD) on the consumer's side of the cut-out. There shall be no exposed-conductive-parts before and/or enclosing the RCD.

The earth electrode must be separated from any PME earth electrode or metallic cable sheath.

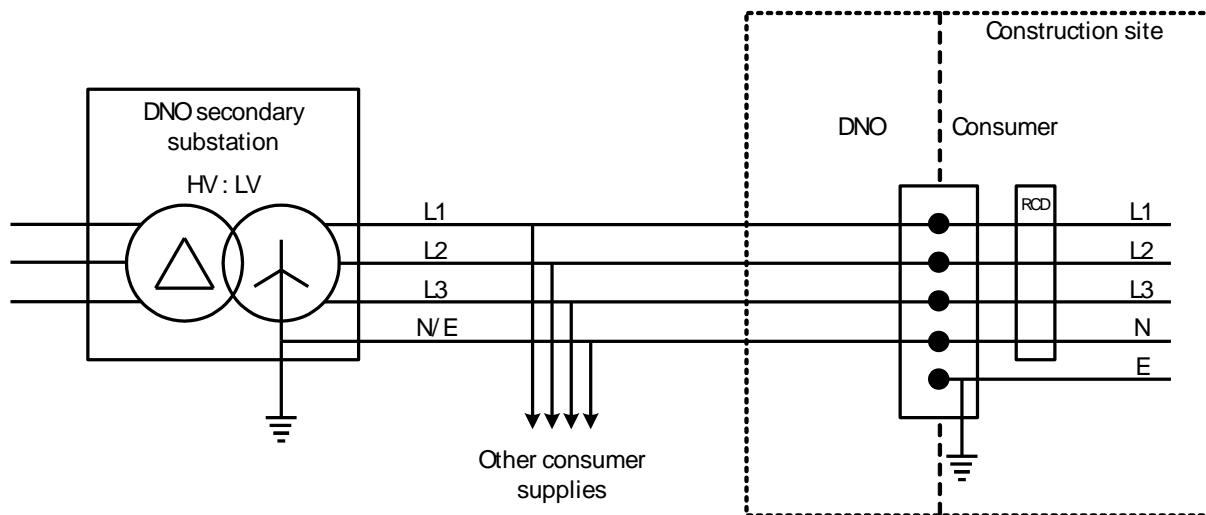

Figure 6.2.2.2: Temporary building supply with a TT earthing system

6.2.2.3 Transition to permanent supply

A permanent supply using PME may be provided to a building provided that:

- The permanent building is complete and there are no reasonable grounds to believe that the installation does not meet the requirements of BS 7671;
- Any scaffolding is not bonded to the construction site TT system earth.

6.2.3 Supplies to temporary installations (not associated with construction sites)

6.2.3.1 Exhibitions, shows and stands

PME shall not be offered if this would allow the connection of the PME earth terminal to any metalwork of exhibitions, shows or stands.

6.2.3.2 Mobile or transportable units

The connection of mobile or transportable units to consumer's installations is governed by the Electricity at Work Regulations and Section 717 of BS 7671. Further guidance on the connection of mobile or transportable units to existing installations can be found in BS 7909.

PME shall not be offered for a dedicated supply to a mobile or transportable unit except as permitted by BS 7671:

- 'where the installation is continuously under the supervision of a skilled or instructed person, and
- the suitability and effectiveness of the means of earthing has been confirmed before the connection is made' and
- subject to the normal PME requirements.

Examples of these situations are outside broadcast vehicles, medical services vehicles/cabins, transportable catering units, technical/facilities vehicles for fire fighting etc. The definition does not include caravans, pleasure craft, mobile machinery and generating sets and traction equipment of electric vehicles.

6.2.3.3 Temporary electrical installations for structures, amusement devices and booths at fairgrounds, amusement parks and circuses

PME shall not be offered if this would allow the connection of the PME earth terminal to any metalwork of temporary electrical installations for structures, amusement devices and booths at fairgrounds, amusement parks and circuses.

6.2.3.4 Supplies to other temporary buildings

For temporary buildings, eg temporary classrooms, a PME earthing terminal may be supplied if the installation is constructed so that a person in contact with the general mass of earth cannot touch any metalwork of the temporary installation and the installation complies with the bonding and earthing requirements of BS 7671. In such cases, a temporary building may be treated in the same manner as a permanent building. A PME terminal shall not be offered for a temporary building which is not constructed as above (e.g. metalclad buildings) .

6.2.4 Agricultural and horticultural premises

Agricultural and horticultural premises are considered to be 'Special Locations' within BS 7671; Section 705 of that standard sets out requirements and recommendations regarding the use of PME (TN-C-S) earthing, equipotential bonding and the application of RCDs.

NOTE: Rooms, locations and areas for household applications and similar are not covered by this section.

Safety issues include:

- Damp locations
- Possibility of contact of the body with true Earth potential
- Presence of livestock

NOTE: In addition to normal electric shock hazards to persons, livestock are sensitive to small potential differences and may experience low level shocks or tingles from voltages imported via the neutral/earth conductor of the DNO TN-C-S system.

BS 7671 notes that PME (TN-C-S) earthing is not recommended where a metal grid cannot be laid in the floor and included in the installation's equipotential bonding. In this case each building should be provided with its own earthing installation as part of a TT system by installing a separate earth electrode and fitting appropriate protection in accordance with BS 7671 (eg an RCD).

NOTE: In practice this means that the main service position can be provided with a PME terminal.

The consumer's electrician:

- may use the PME terminal to earth the farm house / offices/ shop etc.
- may use the PME terminal to earth the farm buildings where a metal grid is installed in the floor and included in the equipotential bonding of the installation.
- may segregate the earthing conductor / wire armouring of each circuit and install a separate earth electrode for each building where the full equipotential bonding provision of BS 7671 Section 705 cannot be fully applied.
- Should, in accordance with Guidance Note 5 to BS 7671, advise the consumer that if PME is to be used and the metal grid in the concrete floor cannot be bonded or does not exist, the small voltage differences referred to above may adversely affect livestock feeding and milking.

Where in remote buildings all extraneous-conductive-parts cannot be bonded to the earthing terminal, the pipes and metalwork of isolated buildings, whether or not they have an electricity supply, shall be segregated from metalwork connected to the PME earthing

terminal. Such buildings should be provided with their own earthing installation as part of a TT system by installing a separate earth electrode and fitting appropriate protection in accordance with BS 7671 (eg an RCD). The earth electrode and protective conductor shall be segregated from any metalwork connected to the PME earthing terminal.

Where segregation is not possible then the alternative of converting the whole of the installation to form part of a TT system should be considered.

6.2.5 Swimming Pools and other basins

NOTE: This Section is for the guidance of Network Operators only.

Locations containing swimming pools and other basins are considered to be 'Special locations' within BS 7671. Section 702 of that standard sets out requirements and recommendations relating to the use of supplementary equipotential bonding and RCDs in electrical installations in such locations.

BS 7671 recommends that where PME (TN-C-S) earthing is adopted, an earth mat or electrode should be installed for Zone 2.

Safety issues include:

- Wet locations
- Possibility of contact of the body with true earth potential
- Presence of wet barefoot persons

NOTE: In addition to normal electric shock hazards, persons may experience low level shocks or tingles from the out of balance voltages imported via the neutral/earth conductor of the DNO TN-C-S system.

Competent persons enquiring about the suitability of PME for swimming pool supplies should be advised:

- The main service position can be provided with a PME terminal. It is the electrician's decision whether or not to utilise the PME terminal for all or part of the installation.
- Where the pool is in separate building or outdoors the consumer's electrician:
 - may decide to use the PME terminal to earth the house / offices/ shop etc, or
 - may decide to segregate the earth conductor / wire armouring of the pool building circuit, install a separate earth electrode for the pool building and apply supplementary equipotential bonding as required by BS 7671 Section 702, or
 - may decide to use the PME earth if a metallic grid is installed under the poolside areas and bonded to the equipotential bonding.
- Where the pool is within the same building the consumer's electrician:
 - may decide to use a TT system to earth the entire installation, or
 - may decide to use a TT system to earth the pool installation, and segregate the metalwork and pipes from the rest of the building and connect them to a separate earth electrode, or
 - may decide to use the PME earth if a metallic grid is installed under the poolside areas and connected to the equipotential bonding.

6.2.6 Caravans, boats, marinas, camp sites and amenity/shower blocks (including sports pavilions)

6.2.6.1 Caravans

The Electricity Safety, Quality and Continuity Regulations 2002, as amended, preclude the provision of a PME earthing terminal to a caravan. Supplies to caravans should be from a TT system utilising a separate earth electrode segregated from the PME earth and protected by an RCD which must be provided by the consumer or site owner.

NOTE: This does not preclude the provision of PME to mobile homes which are not of caravan construction (See 6.2.7)

6.2.6.2 Caravan sites, campsites and amenity shower blocks

Due to the higher probability of persons being barefooted at toilet and amenity shower blocks (including sports pavilions with shower facilities) the extension of PME earthing is not recommended unless a buried bonded metal grid has been installed. This requirement also applies to other locations where toilet or shower blocks have been provided for general public use where people are likely to be barefoot e.g. beachside locations, parks etc.

Where outside showers have been provided, provision of PME earthing is not recommended as providing a reliable equipotential cage may prove impractical.

Where no shower area exists nor is likely to exist in a sports pavilion, PME may be offered provided the appropriate metalwork is bonded and due consideration is given to the construction of the building, ie wooden or brick construction.

NOTE: This does not preclude a PME earthing terminal being provided for use in permanent buildings on a caravan site such as the site owner's living premises and any bars or shops.

6.2.6.3 Boats and marinas

The Electricity Safety, Quality and Continuity Regulations preclude the provision of a PME earthing terminal to a boat. Supplies to boats should be from a TT system utilising a separate earth electrode segregated from the PME earth and protected by an RCD which must be provided by the consumer or site owner.

NOTE: This does not preclude a PME earthing terminal being provided for use in permanent buildings on a marina site such as the site owner's living premises and any bars or shops.

6.2.7 Mobile homes

BS 7671 section 721 states that for mobile homes the general requirements apply. However, to cover the possibility that certain mobile homes could fall within the scope of a caravan for the purposes of the Electricity Safety, Quality and Continuity Regulations 2002, as amended, the following guidance is given.

For the purposes of this Engineering Recommendation, a mobile home is to be treated as a caravan if:

- any metalwork connected to the earth terminal is within reach of a person in contact with the general mass of earth, or
- it is not permanently sited, or
- it is not permanently connected to water or sewerage services.

This definition does not include mobile or transportable units (e.g. outside broadcast vehicles) which are covered in paragraph 6.2.3.2.

6.2.8 Mines and quarries

Provided the building's electrical installation wiring conforms to BS 7671, a PME earth terminal can be provided to mine/quarry permanent buildings (e.g. permanent offices and canteens). This excludes amenity shower blocks unless an earth grid is installed. Supplies to underground shafts, the production side of quarries or associated amenity shower blocks shall be from a TT system having a separate connection with earth, independent of the PME earth terminal. Where a mine or quarry requires a supply both to a permanent building and either an underground shaft or the production side of the quarry, precautions must be taken to ensure that these latter supplies have an earth system segregated from the PME earth system.

If the site has a dedicated secondary substation that only supplies the consumer it will usually be possible to provide a TN-S earth terminal directly from the transformer neutral.

NOTE: The requirements for supplies to the working areas are covered by specific statutory legislation (see BS 7671, section 110.1).

6.2.9 Fuel filling stations

The filling station area should be supplied from a TT system. BS 7671 clause 331.1 and BS 7671 Appendix 2 give references for the requirement for supplies to fuel filling stations.

Where the filling station is part of a larger site, PME facilities may be provided for permanent buildings such as restaurants and shops, provided the filling station area has an earth system segregated from the PME earth system.

6.2.10 Multiple occupancy buildings

There are a number of issues with regard to the application of PME within multi-occupancy buildings, in particular the requirement for an end-of-main electrode and problems associated with neutral currents flowing within structural steelwork. Whilst a PME supply may be provided at the main intake position, PME is not generally recommended for distribution within multi-occupancy buildings, including multi-storey and single storey buildings. In providing an earth terminal, reference should be made to EREC G87.

6.2.11 External exposed metalwork connected to the internal earth system (including outside water taps)

Under an open-circuit supply neutral condition the potential of external metalwork could rise above earth potential if it is connected to the internal earth. A person coming into contact with it could receive an electric shock and the shock could be severe if that person were barefooted. The probability of these two conditions occurring together is considered to be so small that the use of PME where external exposed metalwork exists is not precluded.

An insulating insert may be incorporated in the pipe to an outside water tap. However, care should be taken to ensure that simultaneous contact with metal pipework on each side of the insert is not possible if there is likely to be a potential across the insert under this condition.

6.2.12 Metal clad buildings

Where metal clad buildings incorporate a steel frame, the steel frame will provide a good connection with the earth which will effectively limit the rise of earth potential.

A PME supply may be provided to a metalclad building provided that:

- a) the metal cladding is bonded to the steel frame.
- b) the supply is either:
 - three-phase with less than 40% unbalance, or

single-phase, provided the frame to earth impedance is less than 20 ohms.

6.2.13 LV Embedded generators

Recommendations for the connection of small scale embedded generators can be found in EREC G83. For larger embedded generators with a capacity greater than 16A per phase the requirements are covered by EREC G59.

NOTE: For photovoltaic installations in buildings, see DTI Publication "Photovoltaics in Buildings – Guide to the installation of PV Systems"

6.2.14 Street lighting and road signs with electrical load of 500W or less

Part II of the The Electricity Safety, Quality and Continuity Regulations 2002, as amended, which covers protection and earthing, applies to supplies to street lighting installations and other street electrical fixtures.

An earth electrode shall be provided at the end of every service supplying more than one street lamp or road sign.

An earth electrode shall be provided at the source pillar or supply point servicing more than one street lamp or road sign. Where the load on the pillar is greater than 500W the earth electrode shall be in accordance with section 6.2.15 of this this Engineering Recommendation

Where a street lamp or road sign is installed within an insulated foundation such as a plastic or non-conductive collar an earth electrode shall be installed connected to the earth terminal at each such installation.

In accordance with BS 7671, bonding conductors shall have a minimum size of 6mm² copper equivalent for supply neutral conductors with copper equivalent cross-sectional areas up to 10mm². For larger sized supply neutral conductors the main bonding shall comply with Table 4.9a.

These requirements apply to street lighting and road signs supplied by a DNO and by a street lighting authority when using CNE cables. In this latter case supply from the DNO is usually to a pillar. See Figure 6.2.14a.

Private installations and local authority installations using SNE cables which are supplied from PME services must comply with Figure 6.2.14b.

The following principles apply:

- a) Bonding of small isolatable metal parts
Small isolatable metal parts, for example small metallic doors and door frames, need not be bonded to earth.
- b) Earth electrodes
All earth electrodes installed must comply with paragraph 4.8.
- c) Earthing terminal
Until the requirements of BS 7671 and this Engineering Recommendation have been complied with, the earthing terminal should be rendered electrically inaccessible so as to prevent unauthorised connection

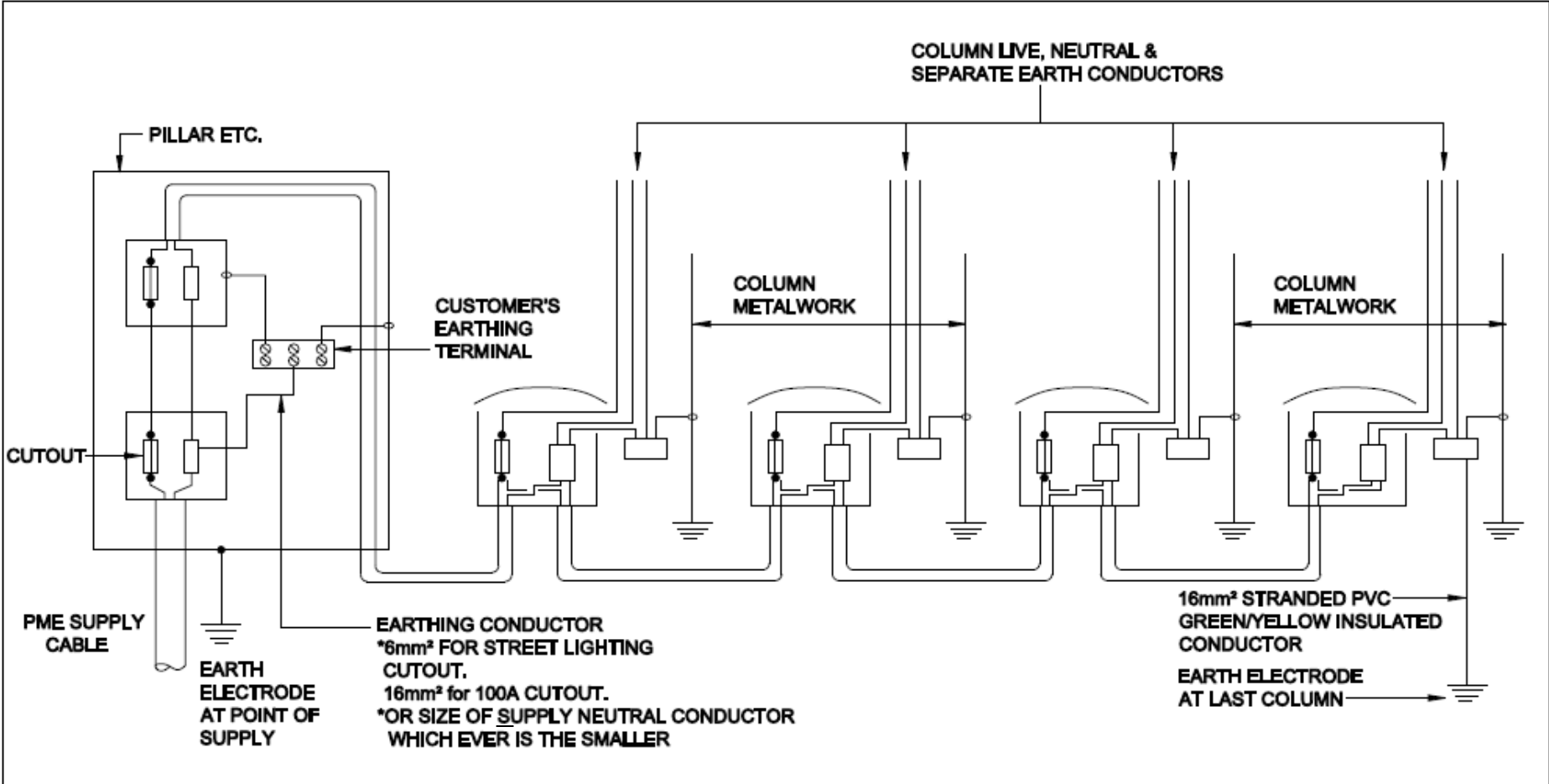

Figure 6.2.14a: Lighting Authority C.N.E. distributor fed from PME service

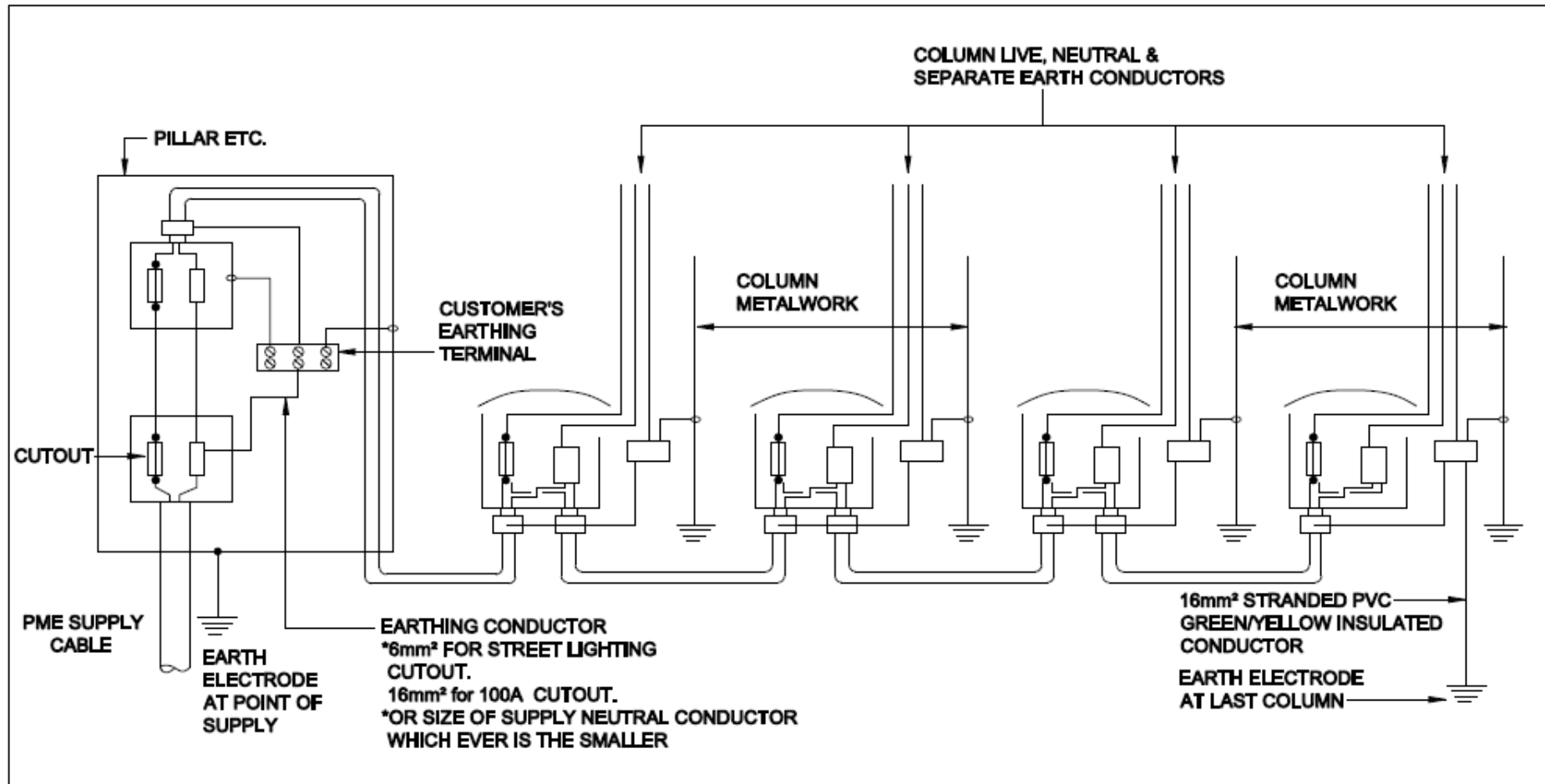

Figure 6.2.14b: Lighting Authority S.N.E. distributor fed from PME service

6.2.15 Street Electrical Fixtures not covered by 6.2.14

This Section covers roadside housings accessible to the public; examples are: cable television distribution cabinets, electric vehicle charging points, electrical distribution cabinets with load above 500W.

NOTE: A code of practice for electric vehicle charging equipment installation has been published by the IET.

Street electrical fixtures should preferably be of Class II construction or equivalent as defined in BS 7671. Examples are public telephones, pedestrian crossing bollards, ticket machines. No mains-derived earthing terminal is required, neither is a residual current device needed for earth fault protection.

Where the street electrical fixture is of Class I construction as defined in BS 7671, (examples include metal enclosures containing pumps, controls or communications equipment), a PME earth terminal may be provided if the requirements of BS 7671 are met and:

- a) For 3-phase equipment, the load is balanced, or:
- b) For 1-phase equipment and 3-phase equipment with unbalanced load, the maximum load and consumer earth electrode resistance bonded to their main earth terminal fulfil the requirements of Table 6.2.15.

Connection	Maximum 1-ph Load or, for 3-phase, maximum unbalance overall load	Maximum consumer earth electrode resistance bonded to main earth terminal (see note)
1-phase or unbalanced phase 3-	500W	100Ω
	1kW	60Ω
	2kW	20Ω
	3kW	14Ω
	4kW	11Ω
	5kW	9Ω

NOTE: By agreement with the Network Operator, it may be permissible to take into account the effect of distributed earths in specific situations.

Table 6.2.15

If the conditions for a Class I installation cannot be met, a PME terminal should not be offered. The earthing system of the installation should form part of a TT system by installing a separate earth electrode and fitting appropriate protection in accordance with BS 7671 (eg an RCD).

Extraneous-conductive-parts (e.g. safety barriers, pedestrian guard rails) should not be connected to a PME earth terminal.

6.2.16 Lightning protection systems

For the majority of situations it is acceptable for lightning protection to be connected to the consumer's earthing arrangements and thus to the DNO PME terminal, where PME is provided. Guidance on the connection of lightning protection conductors to the consumer's earthing is provided in BS EN 62305.

Consideration should be given to the size of bonding conductor, because in the event of an open circuit neutral the consumer's earth electrode may carry most of the diverted neutral current. The size of the consumer earthing and bonding connections may be insufficient for

this current, particularly where the service size is small. Where necessary, DNOs should provide guidance on the bonding requirements.

When periodic testing of the lightning protection system is undertaken, precautions are necessary when breaking the link between the lightning protection electrode and the consumer's earth since the consumer's earth may be at a potential above true earth.

6.2.17 Cathodic Protection Installations

The usual source of power for cathodic protection installations is a mains supplied transformer rectifier unit. Such installations should be supplied from a TT system.

Substation earth electrodes, end of main electrodes and stay wires should be situated as far as possible from the cathodic protection ground bed.

6.2.18 Communication stations

There are a variety of types of 'communication station' including radio/television sites, mobile phone base stations and amateur radio (or 'radio ham') domestic installations. This section is limited to consumer communication stations connected to DNO networks at low voltage.

6.2.18.1 Communication stations with an independent earth electrode

Some communication stations require an independent earth electrode for functional/lightning purposes. Where such an earth is installed its earth resistance may be comparable or less than that of the DNO earthing system. On a PME network, in the event of an open circuit neutral the consumer earth electrode may carry most of the diverted neutral current. The size of the consumer earthing and bonding conductors may be insufficient for this current, particularly where the service size is small.

In order to prevent the possible neutral current diversion detailed above, the consumer should be advised to create a TT earthing system that meets BS 7671 for either:

- a) the whole installation, or
- b) the part of the installation feeding the radio/communication equipment and any associated metalwork

In the case of b), the TT installation earthing must be segregated from the earthing/bonding in the rest of the consumer installation and DNO earthing. With the TT installation, a RCD shall be provided to comply with the earth fault disconnection time requirements in BS 7671.

Where disruption due to possible RCD nuisance tripping would be unacceptable, an alternative to the above TT earthing system is to use TN-C-S earthing for the whole installation and increase the size the consumer earthing and bonding conductors; these shall not be less than the cross-sectional area of the service neutral.

6.2.18.2 Communication station housings/structures accessible to the public

Communication stations with freestanding housings/structures accessible to the public (e.g. some mobile phone base stations) may fall within the scope of paragraph 6.2.15 and/or 6.2.18.1.

6.2.18.3 Shared communication tower/mast

See also paragraph 6.2.18.1.

Communication sites can be sensitive to the effects of diverted neutral current passing through earthing/bonding paths. This can arise with PME at multi-user sites sharing a common communication tower/mast. The neutral current due to load of one user/consumer can cause noise problems with certain consumer earthing practices by passing through

equipment, chassis, signal wires, screening braids etc of other consumers. The noise problems may be overcome if consumers employ earthing practices that eliminate parallel paths for neutral current in earthing/bonding connections. With PME, the practice of providing only a single service connection per communication tower/mast will reduce the above effect. If more than one service is provided then see requirements in 6.2.18.5.

6.2.18.4 TN-S alternative

An alternative non-PME arrangement that avoids the above problems is a TN-S system (e.g. cable sheath earth return with no PME connections), where available.

6.2.18.5 Communication stations on/in other buildings

Where a communication station is located in or on a building that has its own Connection Point, the communication station consumer may ask the DNO for a separate Connection Point (e.g. mobile phone base station on an office building). The issues arising with respect to PME in this case can be similar to those with multiple occupancy buildings (section 6.2.10).

In the following, the term 'Main Building' refers to the building which has the communication station located on/in it.

In general, where the 'Main Building' has a PME earth terminal at its Connection Point then provision of an additional Connection Point to the communication station is not recommended; alternative options to provide an electrical supply to the communication station are as follows:

- a) Private sub-service to communication station from 'Main Building' consumer – see Figure 6.2.18.5, or
- b) Convert the 'Main Building' service and earthing arrangement to provide a TN-S earthing arrangement and provide an additional service with TN-S earthing arrangement to the communication station, or
- c) Convert the 'Main Building' service and earthing arrangement to provide a TT earthing arrangement and provide an additional service with TT earthing arrangement to the communication station.

In general, where the 'Main Building' has a TN-S or TT earthing arrangement then it is not recommended to provide an additional Connection Point with a PME earth terminal.

In general, where an additional Connection Point is provided it is recommended that it shall be from either the same DNO distributing main/service line or the same multi-service distribution board as the 'Main Building'.

NOTE: In the case of additional service(s) into or onto a building there are requirements concerning isolation that must be met in BS 7671, the Electricity at Work Regulations 1989 and the Provision and Use of Work Equipment Regulations 1998.

Figure 6.2.18.5: Permitted service arrangements for communication stations

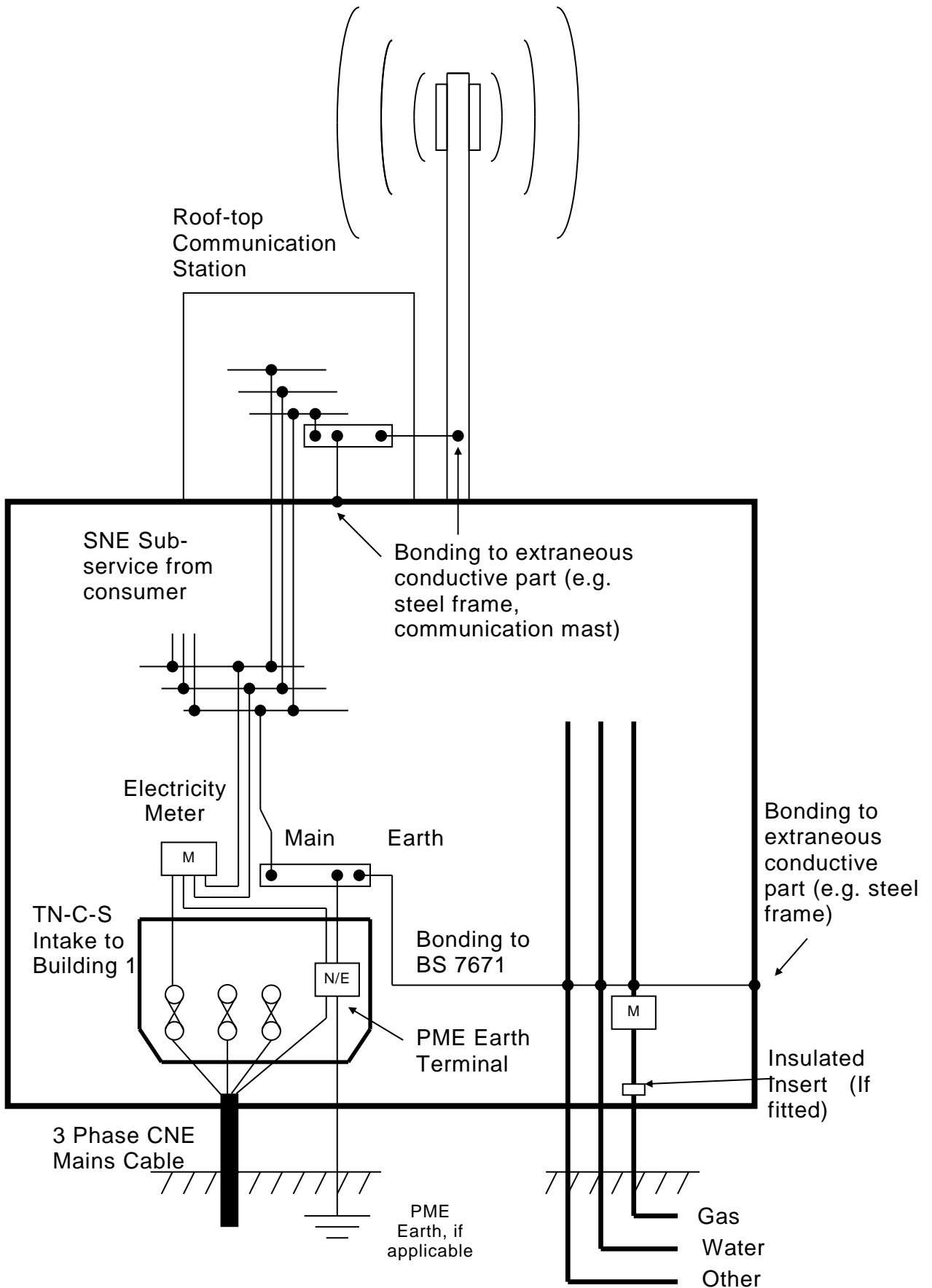

Appendix 1: Extract from the Electricity Safety, Quality and Continuity Regulations 2002, as amended

NOTE: The 2006 Amendment to the Electricity Safety, Quality and Continuity Regulations 2002 excludes traction supplies etc. from the scope of the Regulations.

Continuity of the Supply Neutral Conductor and Earthing Connections

7.— (1) A generator or distributor shall, in the design, construction, maintenance or operation of his network, take all reasonable precautions to ensure continuity of the supply neutral conductor.

(2) No generator or distributor shall introduce or retain any protective device in any supply neutral conductor or any earthing connection of a low voltage network.

General requirements for connection with earth

8.— (1) A generator or distributor shall ensure that—

(a) every network which he owns or operates shall be connected with earth; and

(b) so far as is reasonably practicable, no network which he owns or operates shall become disconnected from earth in the event of any foreseeable current due to a fault.

(2) A generator or distributor shall, in respect of any high voltage network which he owns or operates, ensure that—

(a) the earth electrodes shall be designed, installed and used in such a manner so as to prevent danger in any low voltage network occurring as a result of any fault in the high voltage network; and

(b) where the network is connected with earth through a continuously rated arc suppression coil, an automatic warning shall be given to the generator or distributor, as the case may be, of any fault which causes the arc suppression coil to operate.

(3) Where there is more than one source of voltage in any high voltage network the connection with earth need only be made at one point.

(4) A generator or distributor shall, in respect of any low voltage network which he owns or operates ensure that—

(a) the outer conductor of any electric line consisting of concentric conductors shall be connected with earth;

(b) every supply neutral conductor is connected with earth at, or as near as is practical, to the source of voltage except that where there is only one point in a network at which consumers' installations are connected to a single source of voltage, that connection may be made at that point, or at another point nearer to the source of voltage; and

(c) no impedance shall be inserted in any connection with earth of a low voltage network other than that required for the operation of switching devices or instruments, or equipment for control, telemetry or metering.

(5) A consumer shall not combine the neutral and protective functions in a single conductor in his installation.

- (6) Paragraphs (1) to (4) shall not apply to a generator's network which is situated within a generating station if, and only if, adequate alternative arrangements are in place to prevent danger.

Protective multiple earthing

9.— (1) This regulation applies to distributors' low voltage networks in which the neutral and protective functions are combined.

- (2) In addition to the neutral with earth connection required under regulation 8(4)(b), a distributor shall ensure that the supply neutral conductor is connected with earth at--
- (a) a point no closer to the source of voltage (as measured along the distributing main) than the junction between the distributing main and the service line (the supply neutral conductor of the latter being connected to the protective conductor of a consumer's installation) which is most remote from the source; and
- (b) such other points as may be necessary to prevent, so far as is reasonably practicable, the risk of danger arising from an accidental disconnection of any such connection with earth.
- (3) The distributor shall not connect his combined neutral and protective conductor to any metalwork in a caravan or boat.

Equipment on a consumer's premises

24.— (4) Unless he can reasonably conclude that it is inappropriate for reasons of safety, a distributor shall, when providing a new connection at low voltage, make available his supply neutral conductor or, if appropriate, the protective conductor of his network for connection to the protective conductor of the consumer's installation.

(5) In this regulation the expression "new connection" means the first electric line, or the replacement of an existing electric line, to one or more consumer's installations.

Appendix 2: Operators of AC Electrified Traction Systems in the UK

The following railway operators have confirmed that their design standards will ensure compliance with the requirements of clause 6.2.1.2:

1. Network Rail

Network Rail have provided the following information:

Traction load current voltage rise: Network Rail has measured the voltage rise at a typical location where a DNO earth is available. The maximum measured voltage rise on the running rail was 5.5V. Taking account of the current paths available it is considered that this demonstrates compliance, pending the issue of a design specification.

Fault current voltage rise: Zone 2 clearance times are 0.25s. Typical sections will give voltage rises of 250 – 300V; however the worst case sections will give a rise of 484V for 0.25s. Taking account of the 650V limit at 0.2s, it is considered that this is within the curve between the 0.2s and 3s limits.

2. London & Continental Railways

To be advised

Appendix 3: DC electrified traction systems in the UK

The following methods of construction are employed in the UK:

NOTE: This list is not intended to be exhaustive but to give informative examples.

1. Third rail/overhead supply with return via insulated running rail

The supply is fed via an insulated overhead wire or third running rail mounted on insulators. The running rails are insulated from earth with plastic pads. Neither pole of the supply is earthed.

Where track-circuit signalling is used this relies on effective insulation between the running rails for correct operation.

This system is used on:

Network Rail third rail systems

Tyne and Wear Metro 1,500 V DC overhead system

Information on these systems, and the measures to prevent corrosion due to leakage currents, is given in BS 7430.

2. Third rail supply with return via insulated fourth rail

The supply is fed via a third running rail mounted on insulators, and the return fourth rail is also mounted on insulators. Neither pole of the supply is earthed.

This system is used on:

London Underground (with connections to third and fourth rails to detect earth faults)

Information on this system, and the measures to detect earth fault currents, is given in BS 7430.

3. Third rail supply with return via insulated fourth rail and running rails

This system is used to enable trains equipped for either third or fourth rail systems to run on the same track. The return fourth rail is mounted on insulators, and the running rails are insulated from earth with plastic pads. The running rails and the fourth rail are bonded together. Neither pole of the supply is earthed.

This system is used on:

Lines shared by Network Rail and London Underground

4. Uninsulated return

Tramways are fed via overhead wires with return via running rails embedded in the ground. Special provisions are required to limit stray DC currents in these systems.

The provision of PME or SNE earth terminals to these systems should be assessed on a case-by-case basis.